

SEZIONE SCALA 3:1

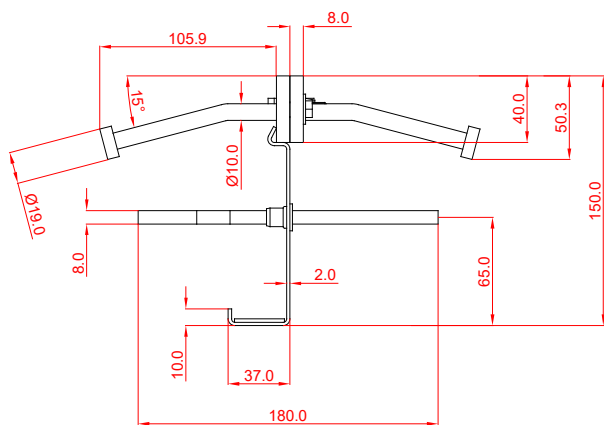

LEGENDA COLORI	
—	COMPONENTI COMMERCIALI
—	LINEE DI SALDATURA
—	QUOTATURE
—	ASSI DI SIMMETRIA
—	LINEE DI SEZIONE

MATERIALE	S235	SCALA	1:1
TRATTAMENTO SUPERFICIALE	A SALDARE		
DISEGNATORE	Luca Falcade	DATA	10/11/2016
CONTROLLO			
APPR.			
RILASCIATO	TIEPPO Group srl		
REVISIONE	00		



GIUNTO TIPO H H150 SENZA GUARNIZIONE LUNG. 3MT

Nr. DIS. **2H1502**

Il presente disegno e' di proprieta' della ditta TIEPPO GROUP SRL, riproduzione e trasmissione a terzi sono vietate a termini di legge.